

ANTUS

2038 x 700
mm mm

80 3/8 x 27 1/2
inches inches

Elettrico / electric / électrique

CODICE / CODE

RS237050SN RS247050SN
RL237050SN RL247050SN

H

2041 mm
80 3/8 inches

L

704 mm
27 3/4 inches

REGOLATORE DI POTENZA
DIGITAL HEAT CONTROLLER
REGULATEUR DE PUISSANCE

INGOMBRO CON ATTACCO LUNGO
MEASUREMENTS WITH LONG BRACKETS
MEASUREMENTS AVEC ATTACHE LONG

INGOMBRO CON ATTACCO STANDARD
MEASUREMENTS WITH STANDARD BRACKETS
MEASUREMENTS AVEC ATTACHE STANDARD

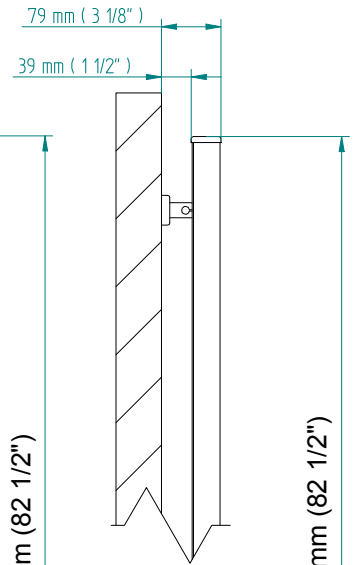
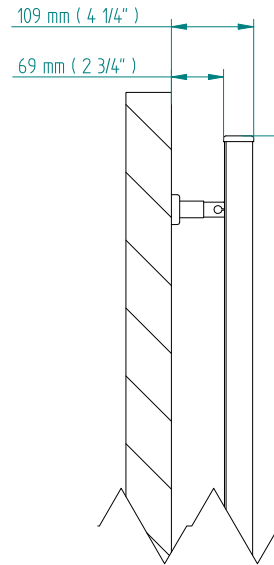
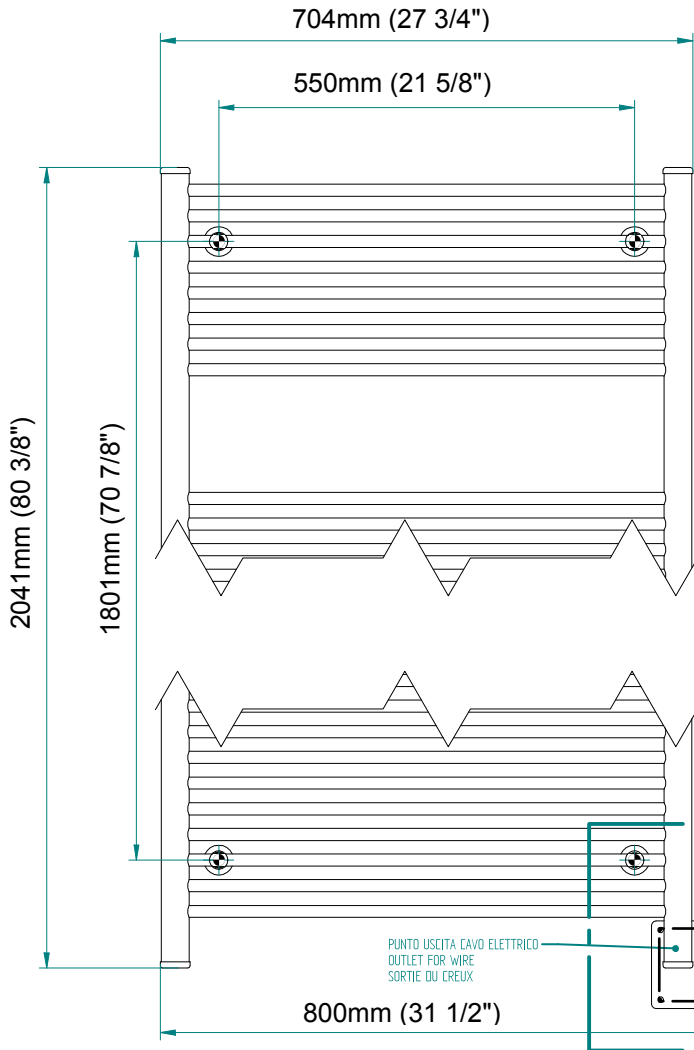

A

B

54 mm (2 1/8")

54 mm (2 1/8")

DETAIL A

DETAIL B

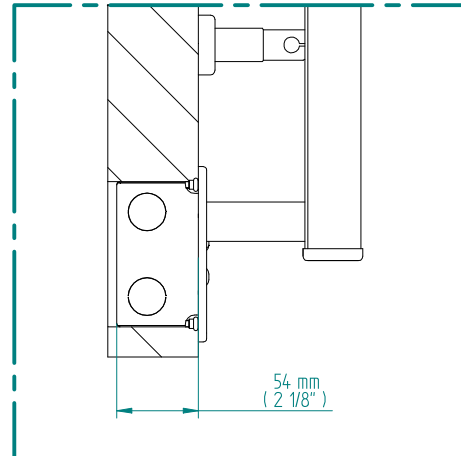
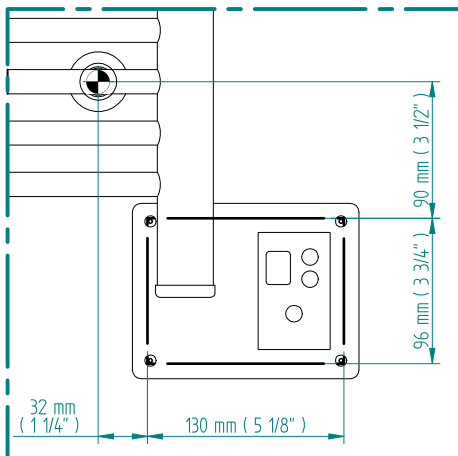

FORO PER INSERIMENTO TASSELLO A MURO 6X30
POSITIONING OF FASTENERS FOR FIXING TO WALL
FASTENERS SHOULD BE SECURED IN DTUDS OR HEADERS PLACES BEHIND THE UNIT
TROU POUR LA CHEVILLE A MUR

Femmestee®