

QUADRO 1084 x 620

mm

mm

42 5/8
inchesx 24 3/8
inches

Elettrico / electric / électrique

CODICE / CODE

RS436016SN	RS446016SN
RL436016SN	RL446016SN
RV436016SN	RV446016SN

H

1084 mm
42 5/8 inches

L

620 mm
24 3/8 inches

REGOLATORE DI POTENZA
DIGITAL HEAT CONTROLLER
REGULATEUR DE PUISSANCE

INGOMBRO CON ATTACCO LUNGO
MEASUREMENTS WITH LONG BRACKETS
MEASUREMENTS AVEC ATTACHE LONG

INGOMBRO CON ATTACCO STANDARD
MEASUREMENTS WITH STANDARD BRACKETS
MEASUREMENTS AVEC ATTACHE STANDARD

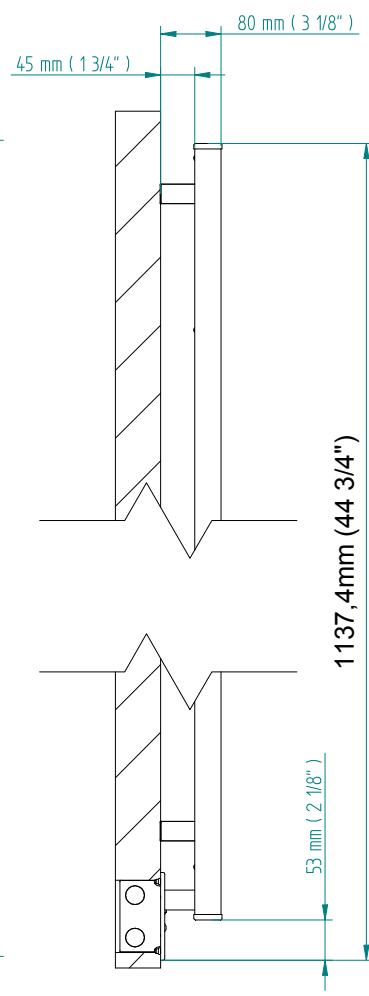
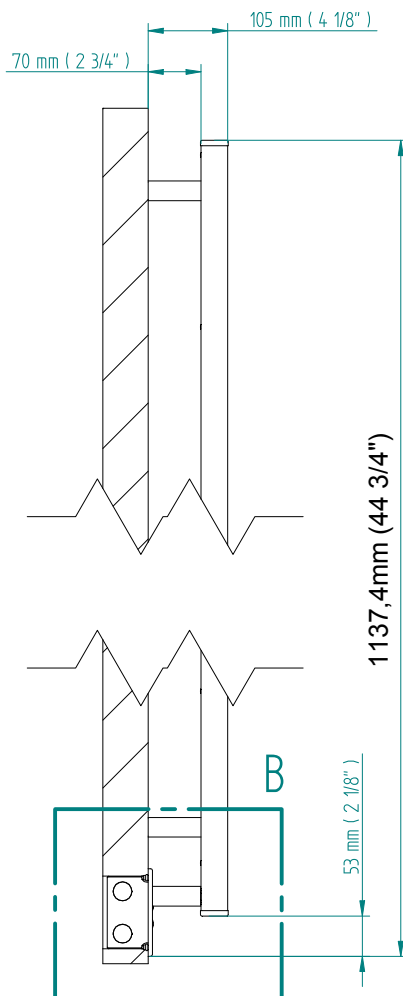
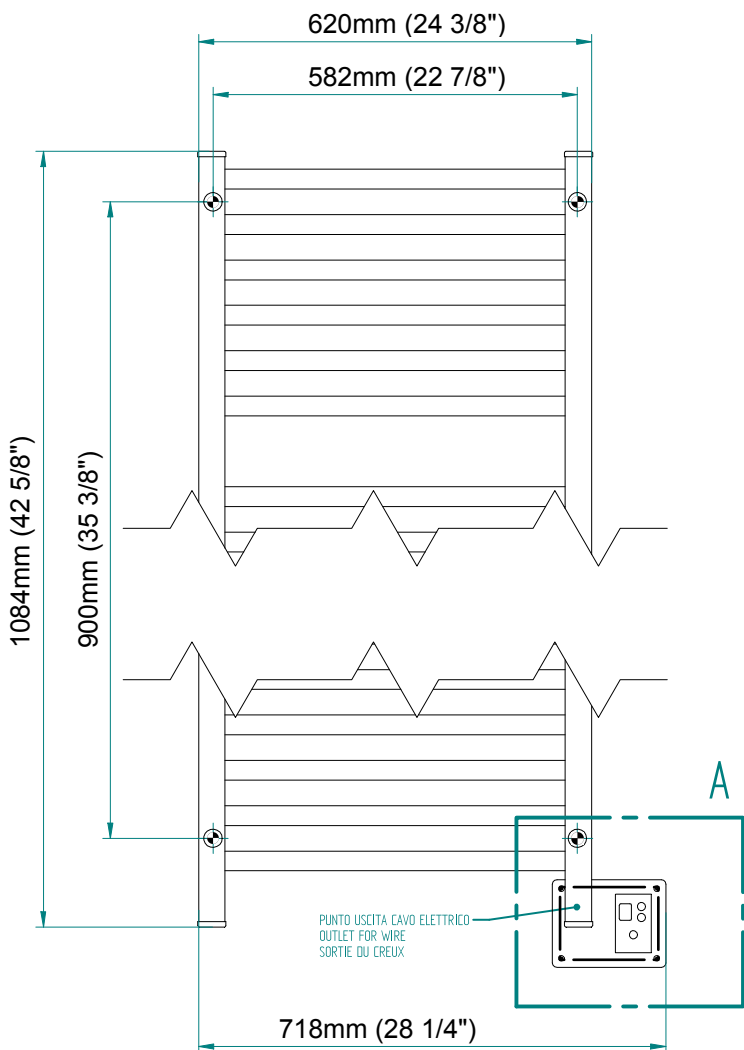

DETAIL A

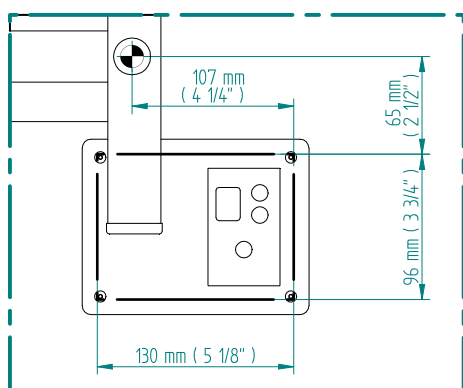

DETAIL B

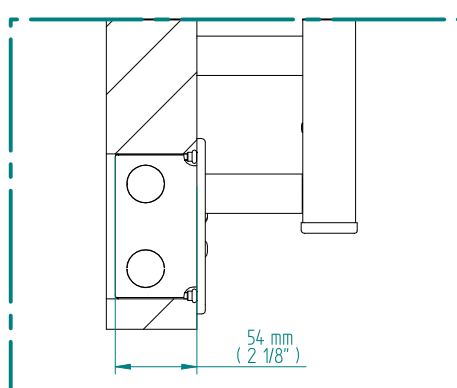

FORO PER INSERIMENTO TASSELLO A MURO 6X30
POSITIONING OF FASTENERS FOR FIXING TO WALL
FASTENERS SHOULD BE SECURED IN DTUDS OR HEADERS PLACES BEHIND THE UNIT
TROU POUR LA CHEVILLE A MUR